

# **HSDJETS<sup>®</sup>**

# TURBOJET T-33 ASSEMBLY AND DEBUGGING GUIDE

V1.0

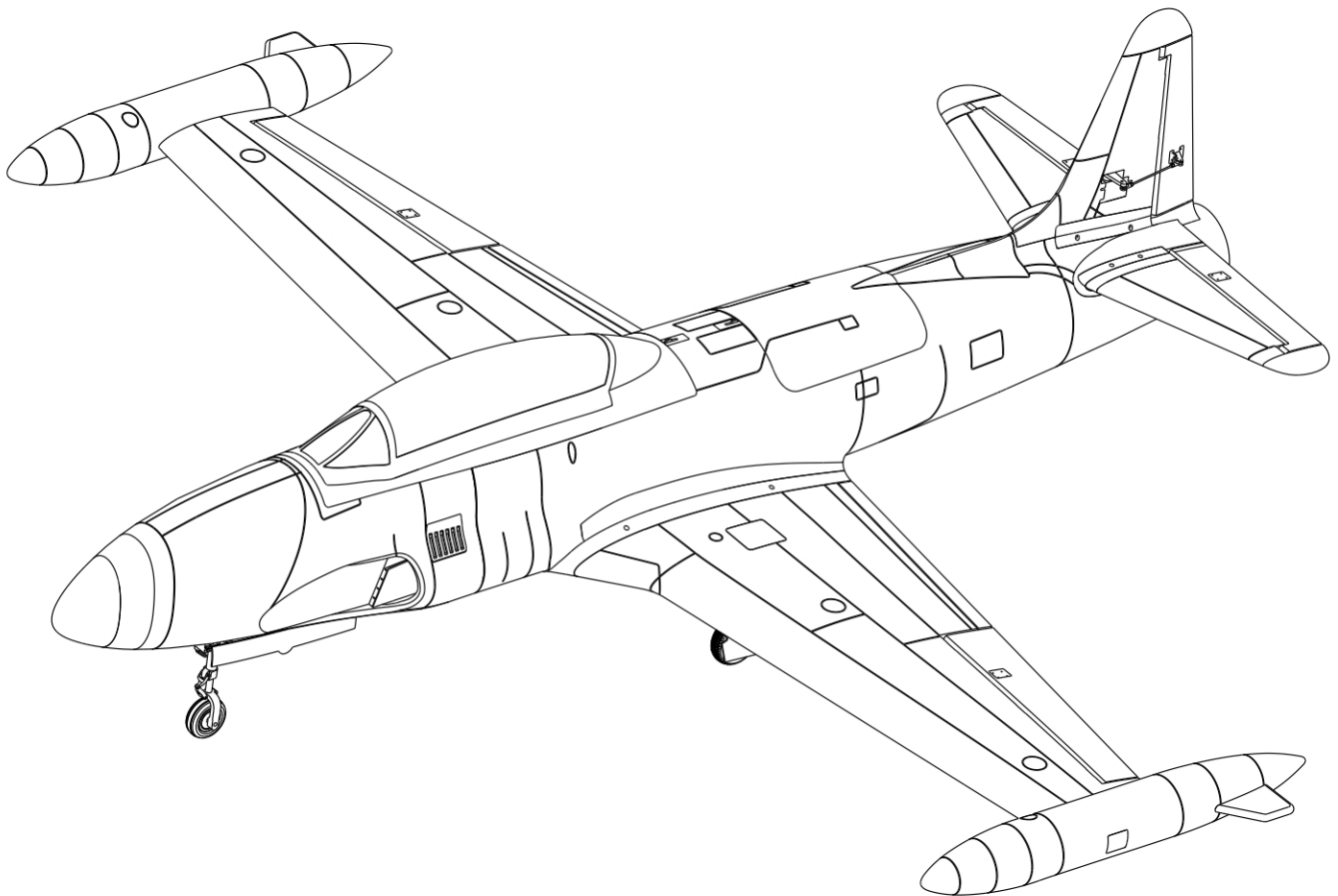

Product S/N:

Want to learn more about the product video,  
pictures, and other matters of attention Please  
log in: [www.hsdr.com](http://www.hsdr.com)

## INDEX

Introduction -----	03
Important hints -----	03
Safety Flight Instructions -----	04
Description of each component -----	08
Install instructions 1: Open the box -----	09
Install instructions 2: Install the nose and fuselage -----	10
Install instructions 3: Install the left and right horizontal tails -----	10
Install instructions 4: Install the vertical tail -----	11
Install instructions 5: Installation of auxiliary fuel tank -----	11
Install instructions 6: Install the main wing -----	11
Boot process -----	12
Aileron test -----	12
Aileron adjustment -----	13
Elevation test -----	13
Elevation adjustment -----	14
Direction test -----	14
Direction adjustment -----	15
Flap test -----	16
Flaps adjustment -----	16
Landing gear testing and adjustment -----	17
Ground test and adjustment -----	18
Pre-takeoff center of gravity test -----	19
Landing gear decomposition graph -----	20
Specification and configuration -----	22

## Introduction

Thank you so much for purchasing T-33 Jet plane, What you have now is the latest T-33 Jet plane product of HSDJETS. This model has the following features:

01. Scale appearance with a classic look and attention to detail with state of the art electronics.

02. The Airframe is constructed of 20 times ultra high-density and high-strength EPO foam. This makes for a very durable aircraft that resists many not so welcomed occasions!

03. HSDJETS has invested in the independent development of an exclusive control system to fully integrate the landing gear, various channel servos, power, lighting and other systems to reduce complicated wiring.

04. The integral main wing has carbon fiber rod and glass fiber rib frame embedded inside the main wing. The strength of the integral main wing is obviously improved and the torsion resistance is stronger.

05. With CLARKY15 flat-convex airfoil, the lift coefficient is large, so that T-33 can easily control the aircraft to a stable flight attitude at low speed.

06. This T-33 utilizes 11 high precision 7.4V high voltage all metal gear digital servos for much better precision, reliability, power and strength!

07. Sequencing on-board LED Lighting System gives the T-33 an extremely

scale appearance.

08. The Tail Afterburner has a Full Ring of LED lights that will increase in intensity and decrease intensity with your throttle stick input! Giving the T-33 an After Burner Glow that is just awesome to watch!

09. Featuring an all new Anti-Bubble Fuel Tank design and built-in fuel filter. This will greatly and more effectively prevent air bubbles from entering the Engine and may cause a Flame Out.

10. All new wing plug design for easy wing attachment using high quality plug materials for reliability and ease.

11. Two reinforcement bars inside the fuselage in order to leading the connection between the wings and the fuselage, meanwhile, level up the overall strength of wings and fuselage.

12. The connection mode between front and rear electric retractors and landing gear is updated. The original 5 mm diameter fixed axle is cancelled. The 11 mm diameter landing gear leg is locked directly in the electric slot, so that the landing gear leg can withstand stronger impact and is not easy to bend.

We believe that T-33 Jet plane will bring you excellent flight.

Before starting, please read our manual carefully.

## Note



**This is not a toy, it has the potentially dangerous, not for children under 14 years. Young people under the age of 14 should only be permitted to operate the model under the instruction and supervision of an adult. Please keep these instructions for further reference after completing model assembly.**

## Important hints

1. Operator should have a certain experience, beginners should operate under the guidance of professional players;
2. Before install, please read through the instructions carefully and operate strictly under instructions;
3. Cause of wrong operation, HSDJETS and its distributors/dealers will not be held responsible for any losses;
4. Model planes players must be on the age of 14 years old;
5. This plane used the EPO material with surface spray paint, don't use chemical to clean, otherwise it will damage;
6. You should be careful to avoid flying in areas such as public places, high-voltage-intensive areas, near the highway, near the airport of any other place where laws and regulation clearly prohibit;
7. You can not fly in bad weather conditions such as thunderstorms, snow, and etc;
8. Model plane's battery, don't allowed to put in everywhere. Storage must ensure that there is no inflammable and explosive materials in the round of 2 meter range;
9. Damaged or scrap battery should be properly recycled, it can't discard to avoid spontaneous combustion and fire;
10. In flying field, the waste after flying should be properly handled, it can't be abandoned or burned;
11. In any case, you must ensure that the throttle is in the low position and transmitter switch on, then it can connect the li-po battery in aircraft;
12. Do not try to take planes by hand when flying or slow landing process. You must wait for landing stop and when the blades stop turning, first disconnect the power supply and then carry it;
13. Whether flying or debugging on the ground, always ensure that there is no one in front of the aircraft.

## Safty Flight Instructions

**Strongly suggestion: users while enjoying the flying, please ensure that you are in a safe and reasonable environment.**

1. It is better to try to choose an empty airspace and no obstacles conditions when you fly.
2. Stay away from people, animals, buildings, trees, water and other obstacles during flying.
3. Please keep the radio transmitter in your hand during the flight to control the model at any time to prevent accidents.
4. Please control the height of the aircraft to 120 meters to ensure the flight safety of the flyer and civil aviation. If you are in the area that have restrictions on flying altitude of 120 meters or less, please comply with its regulations. Make sure the model do not go out of sight and cause unnecessary accidents.

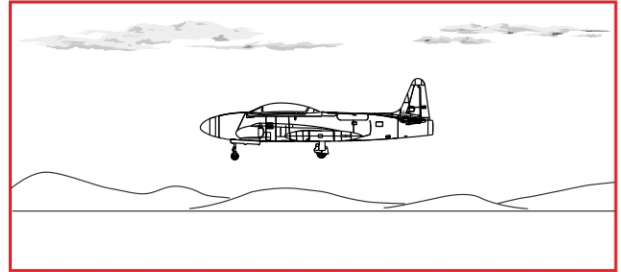

### Flight environment requirements

1. Do not fly in areas such as transmission towers, communication base stations, high-voltage lines, or Wi-Fi hotspots to prevent the radio transmitter signal is interferenced.
2. Do not operate in bad weather, such as: strong winds(wind speed 10 m/s and above), raining, lightning, fog, snow, etc..
3. Flying is not recommended at altitudes above 4,500 meters and in the Arctic and Arctic circles.
4. Do not fly in airports or restricted areas under the relevant laws or regulations.

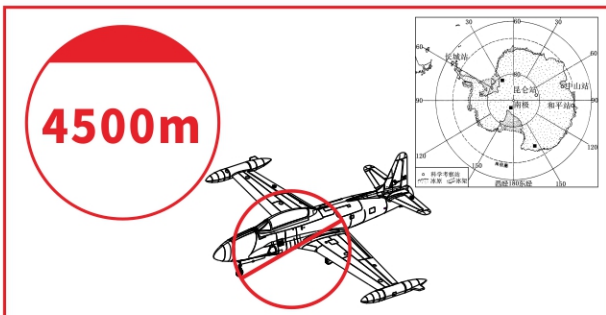
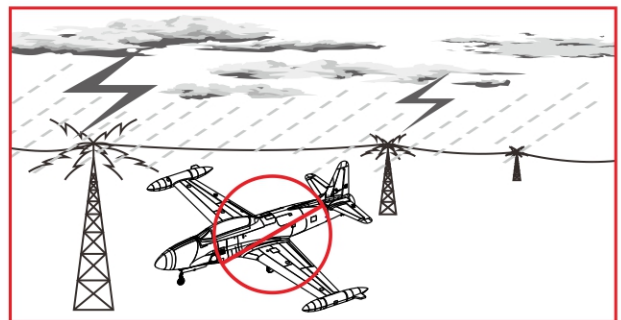
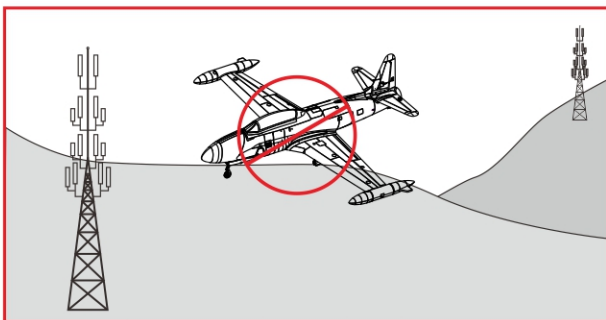

## Warm Prompt

The service life of the turbine is directly related to the operation environment and operation methods. The turbine uses the most streamlined structure to achieve the most extreme working state. Each spare part is designed and produced in the extreme, and the working conditions are extremely harsh.

Do not dismantle the inlet and spindle structures by yourself. In case the turbine is dismantled, it must be re-installed in accordance with the specifications to achieve the original performance. Arbitrary assembly will cause the turbojet body to lose balance, and high-speed operation will cause serious consequences.

## Safety Instructions

※ Please be sure to read the following safety instructions and prepare the emergency equipment before operation.

The micro-turbine is only use on the aircraft moel. The operating state of the turbine is in a high speed and high temperature, which is quite dangerous. Users must read the product instructions before using the turbine. be familiar with the operation procedures of various functions, and understand the safety risks that may result from wrong operations. Wrong operations or parameter settings may cause damage to the engine equipment and endanger to the personal safety. Please strict compliance with product operation regulations.

※ If you are operating the turbojet engine for the first time, please work with someone with experience.

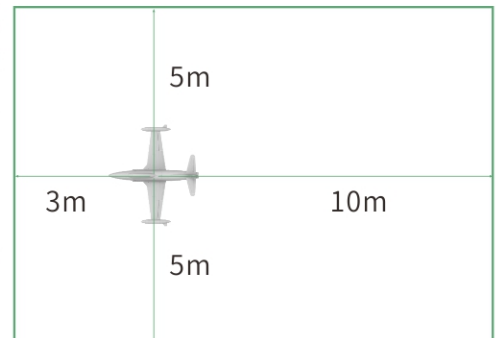

### 1. Safe distance

The turbine works at a very high speed. All persons must keep a safe distance to the turbine when it is running. The turbine must keep a distance of three meters in front of it. A distance of five meters in the left and right sides, and a distance of ten meters should be kept in the rear due to there is high temperature and heat from the tail pipe.

## Safety Instructions

### 2. Personal Safety Protection and Fire Emergency Equipment

Carbon dioxide extinguishers should be prepared at any time and placed within 2 meters of the engine. In case of danger, persons present can use it immediately. Dry powder fire extinguisher is strictly prohibited. If the powder is sprayed into the turbine, it will cause serious wear and tear of the turbine. Suggesting to use of soundproof earmuffs and goggles. The soundproof earmuffs can block the huge sound pressure and prevent hearing damage. After filling the turbine tank with fuel, the fuel equipment must be placed at a distance out of three meters. The goggles can prevent oil or foreign bodies from splashing.

#### Prepare fire extinguisher or powerful hairdryer and earmuffs.

Carbon dioxide extinguishers or the turbine dedicated power Hairdryer should be prepared at any time, and use earmuffs to block the huge sound pressure to prevent hearing damage.

It must be a carbon dioxide fire extinguisher.



OR



The turbine dedicated power Hairdryer

Recommend

+



Earmuffs(headset)

The pictures for reference only.

Dry powder fire extinguisher is strictly prohibited. If the powder is sprayed into the turbine, it will cause serious wear and tear of the turbine.

### 3. Turbine fuel and specialized lubricants

The kerosene or diesel oil can be used in the turbine, must mix with 5 % turbine special lubricant regardless when you use one of each of them. We recommend the use of Mobil Pegasus II turbojet special lubricant.

1 L = 0.8 kg, one pot mix with 20 L(16 kg)

Recommend



The pictures for reference only.

## Safety Instructions

### 4. Other security matters

※ When the engine is running, the air intake is like the vacuum. Do not draw your hand close to the air intake of the engine to prevent it from being inhaled. The air intake should be kept clear and the signal transmission wire should be properly fixed.

※ The engine inlet is suggested to be equipped with protective isolation net to prevent serious damage to the engine caused by foreign bodies.

※ There will be a large amount of high temperature heat when the engine is working, and the exhaust temperature can be as high as 650 °C. Please pay attention to the insulation and protection measures of the surrounding equipment.

※ It is absolutely forbidden to start the turbine indoors. When the turbine is working, it will consume a lot of oxygen. It may cause suffocation of indoor personnel. The hot air and strong air flow that are discharged may ignite dry inflammable materials and blow debris.

※ The turbine jet's flying speed is extremely fast. It is necessary to pay attention to the distance of the operating airspace and the safety of civilian buildings and personnel and vehicles on the ground.

※ The turbine jet can easily reach speeds above 300km/h. Therefore, it is necessary to pay attention to the reliability of the aircraft's rudder surface. It is recommended that the aircraft should be equipped with wing deceleration or wheel braking equipment.

※ The AMA Association of the United States has a maximum speed limit of 320km/hr.

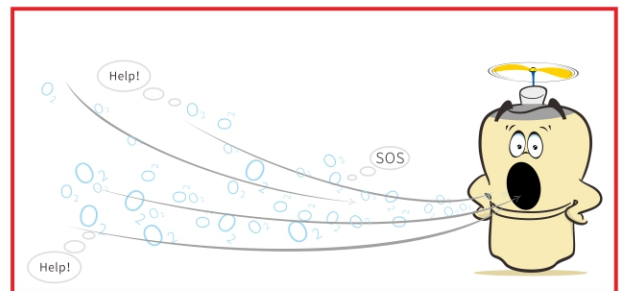

### Special tip:

The service life of the turbine jet will be directly affected by the operate environment and operate mode. The turbine jet uses the most streamlined structure to achieve the most extreme operating state. Each spare part is designed and produced with high precision, and the rotating parts have undergone high-speed dynamic balance correction, as the working conditions are therefore extremely demanding. Users should not dismantle the turbine. Once the turbine is dismantled, it must be re-installed in accordance with the specifications to achieve the original performance. Arbitrary disassembly / assembly will cause the turbine body to lose balance. High speed operation can cause the leaf disintegration or damage to the combustion chamber or other severe consequences.

\* Turbine manufacturers also do not provide any product safety and maintenance guarantees for users to disassemble / assemble by themselves.

## Description of each component

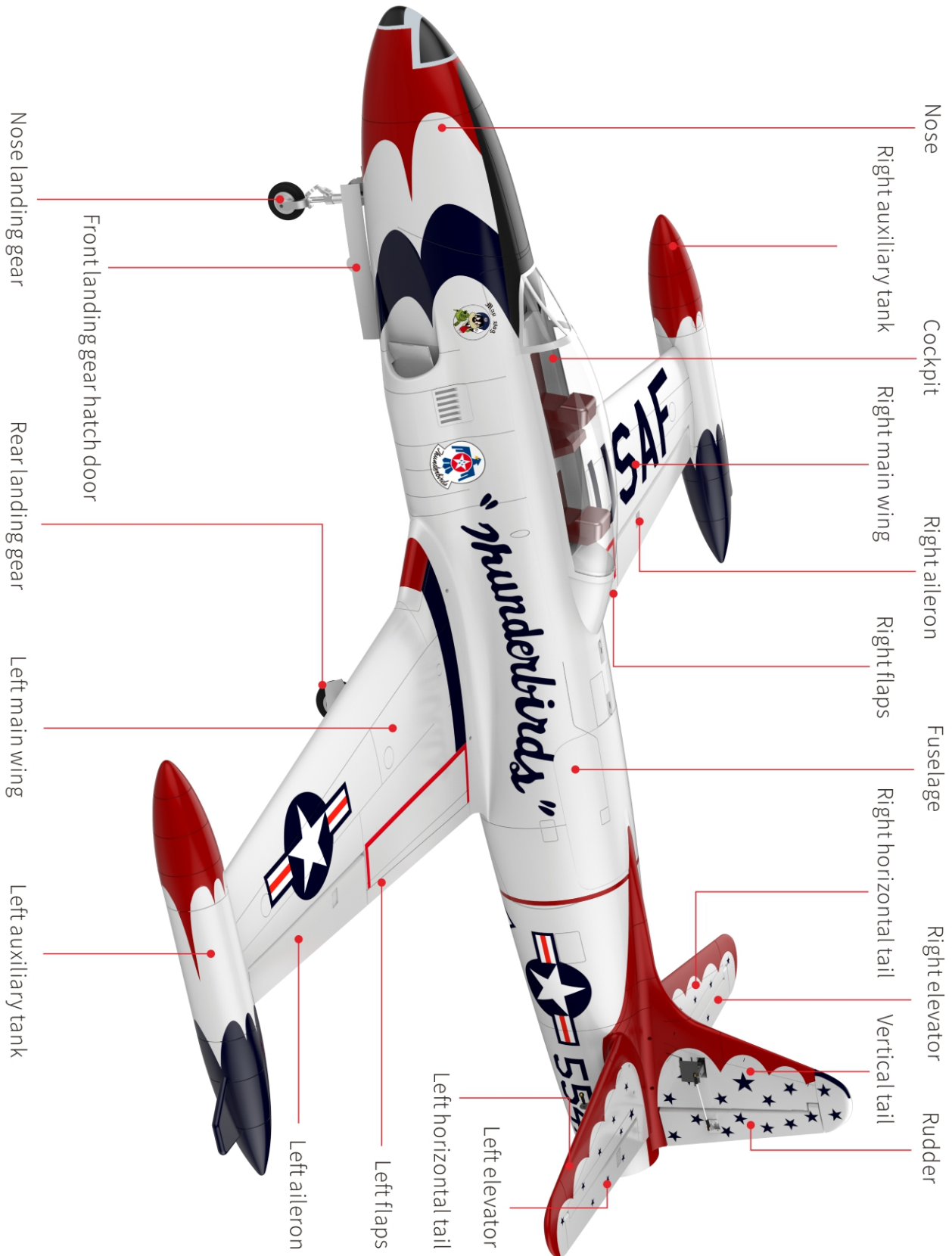



## Install instructions

**1. Open the box(PNP version):** Take the fuselage, left and right main wings, nose, cockpit, vertical tail, left and right flat tail, manual, wing reinforcement bar, flat tail reinforcement bar, decals, accessories package and other items in order. Check the packing items according to the packing item list in the manual. If there are any missing, please contact the dealer to make it up.



Fuselage×1

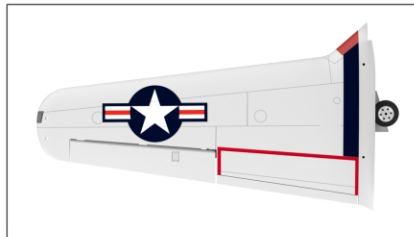

Left main wing×1

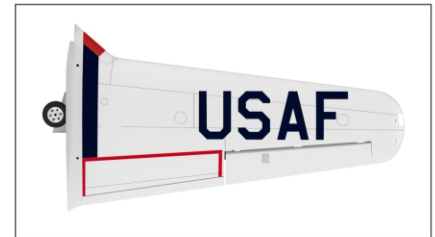

Right main wing×1



Nose×1

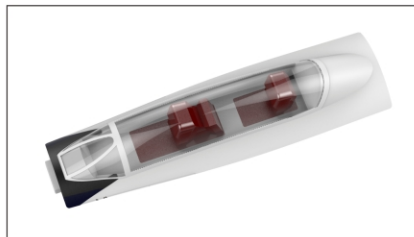

Cockpit×1

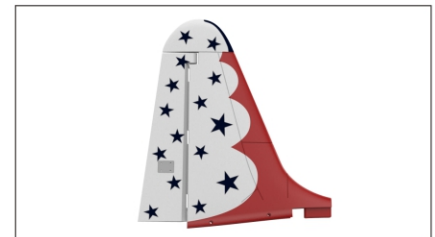

Vertical tail ×1

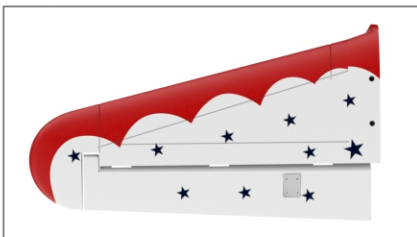

Left horizontal tail×1

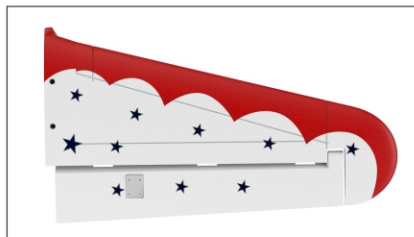

Right horizontal tail×1

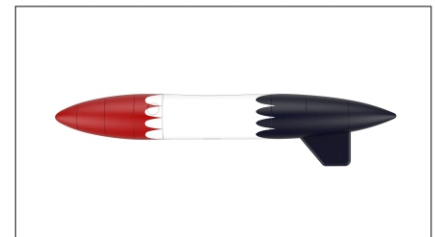

Left auxiliary tank ×1

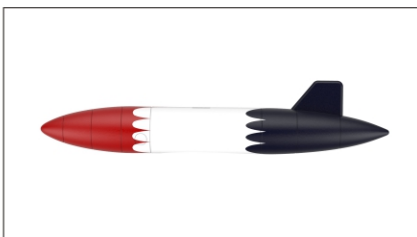

Right main wing ×1

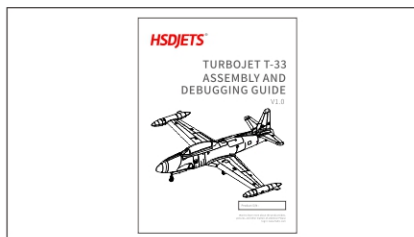

Manual×1



Main wing reinforcement bar×1

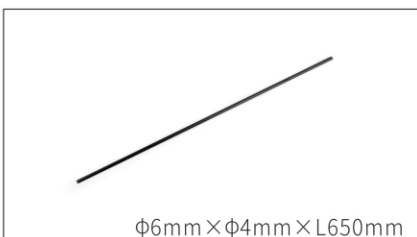

Horizontal tail reinforcement bar×1

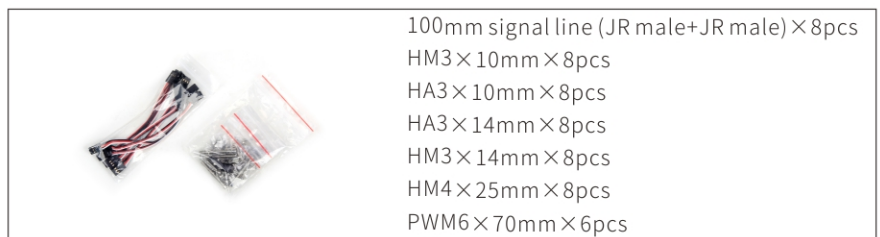

Accessories package×1

100mm signal line (JR male+JR male)×8pcs  
 HM3×10mm×8pcs  
 HA3×10mm×8pcs  
 HA3×14mm×8pcs  
 HM3×14mm×8pcs  
 HM4×25mm×8pcs  
 PWM6×70mm×6pcs

## Install instructions

**2. Install the nose and fuselage:** Take the nose and fuselage from the PE bags, and place them on a flat and clean table, make the four screw holes of the nose to match the corresponding three screw holes of the fuselage, and use screws (HM6 × 70mm × 3pcs) to fix. Then connect the signal wiring at the head end and the fuselage respectively. The color of the wire should connect with the same color and can not be inserted backwards. Note: If you want to be more secure, you can apply EPO glue to the contact section of the fuselage and screw it before fixing it.

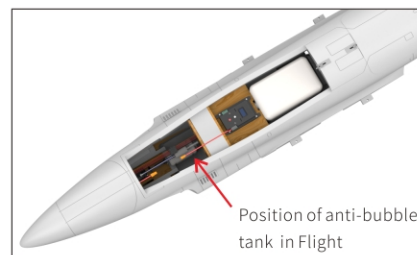
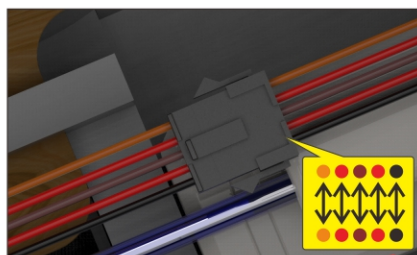
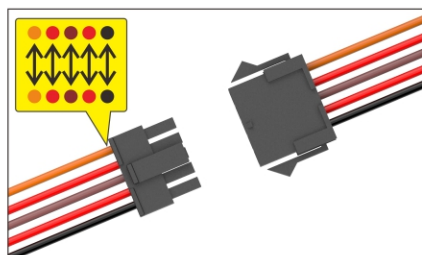
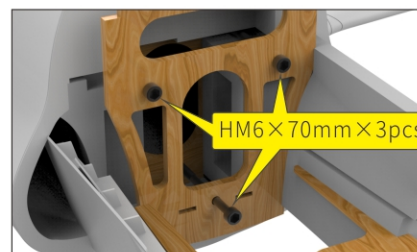
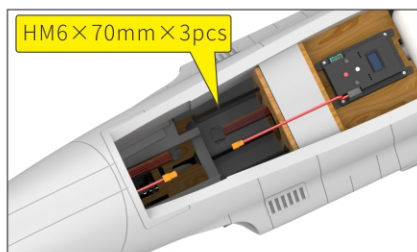
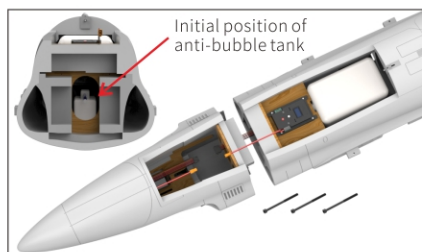

**3. Install the left and right horizontal tails:** First, the horizontal tail reinforcement bar ( $\phi 6\text{mm} \times \phi 4\text{mm} \times L650\text{mm}$ ) is passed through the designated hole position of the fuselage and ensure that the length of the flat tail reinforcement rod at the left and right ends of the fuselage must be equal, and then fix the left and right horizontal tail to the bar, before fully fixing, the servo signal lines of fuselage side and horizontal tail side should be inserted. Note: wire color to color, can not be inserted backwards. After the installation is in place, it is fixed with a screw (HM3 × 10mm × 4pcs).

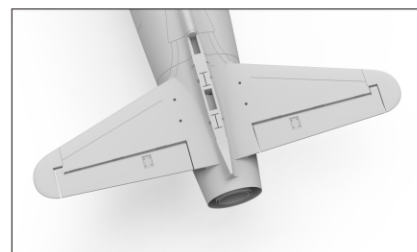
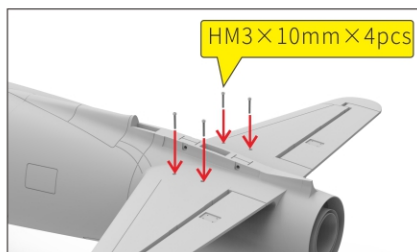
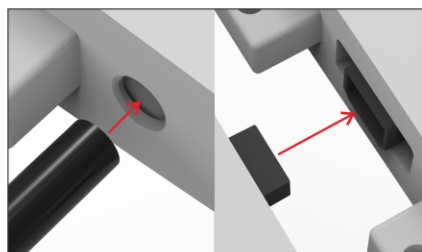
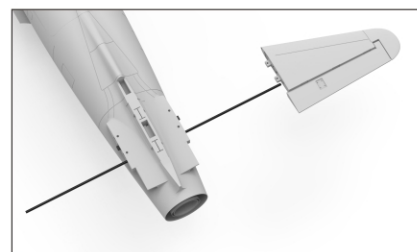
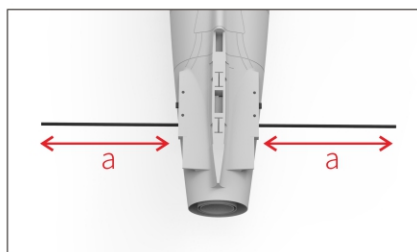
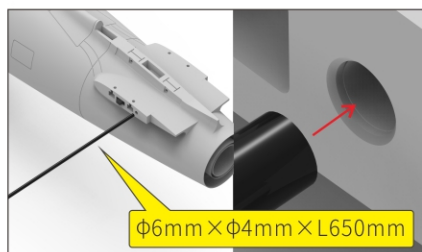

## Install instructions

**4. Install the Vertical tail:** take the tail from the PE bag and install the tail in the designated position of the fuselage. Before fixing, insert the servo signal line of the tail side and the signal line of the fuselage side firstly. Note: The wire color is to same color, can not be inserted backwards; After the installation is in place, fix with the screws(HA3 × 10mm × 4pcs).

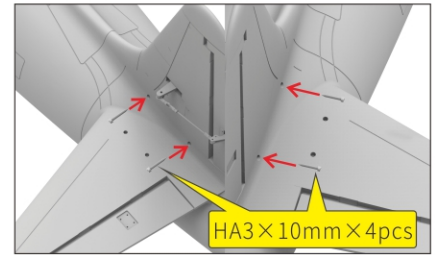
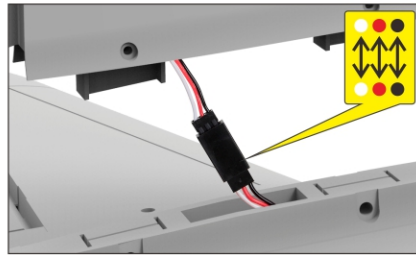
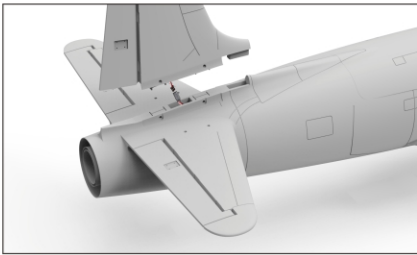

**5. Installation of auxiliary fuel tank:** Remove the auxiliary fuel tank from PE bag, install the auxiliary fuel tank in the designated position of wing, install it in place, and then fix it with screw. (HM 4 × 25mm × 4pcs).

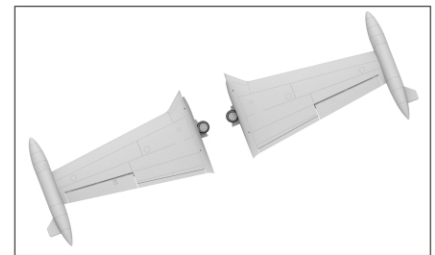
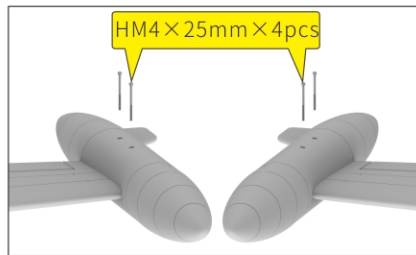
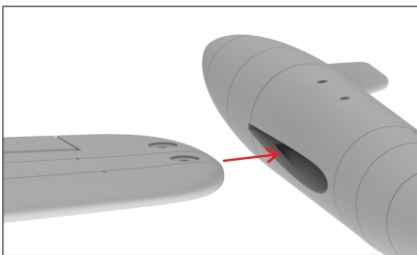

**5. Install the main wing:** make the main wing reinforcement rod ( $\phi 16\text{mm} \times \phi 12\text{mm} \times \text{L}820\text{mm}$ ) ( $\phi 10\text{mm} \times \phi 8\text{mm} \times \text{L}760\text{mm}$ ) to pass through the designated hole position of the fuselage, and ensuring that the length of the main wing reinforcement rod at the left and right ends of the fuselage must be equal, and then fix the main wings. Before fully embedding, ensure to insert the signal lines of the main wing side end and the fuselage side. After installation, fix with the screw (HM3 × 14mm × 4pcs).

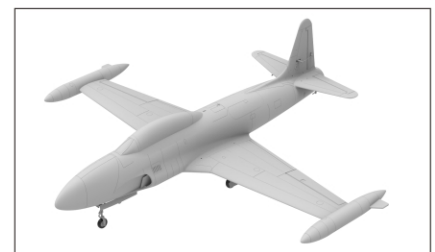
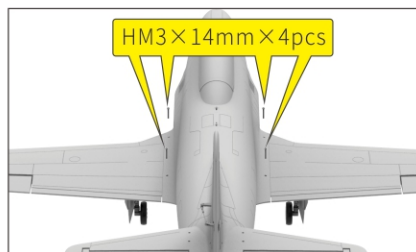
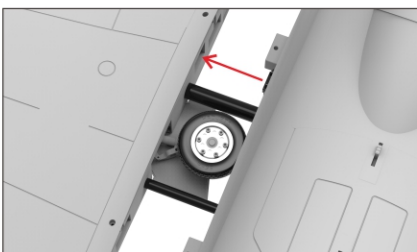
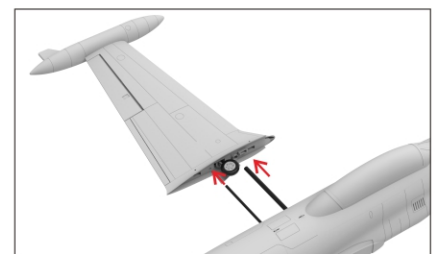
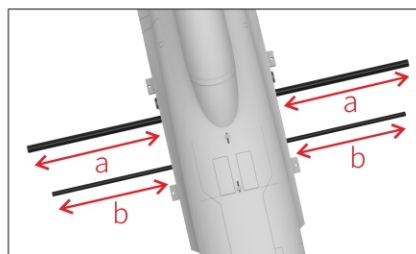
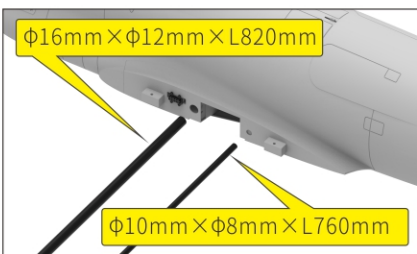

## First test and adjustment after assembly

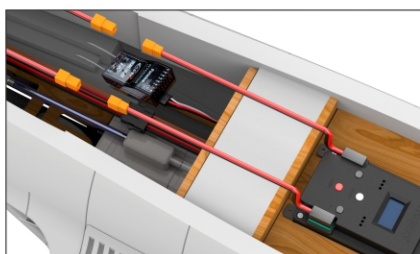

1. To find the S-BUS line at the location of the Super Integrated Control Box and connected to the receiver S-BUS port. (Note: If the receiver does not support S-BUS, the integrated control box needs to be connected to the PWM signal line connection;)

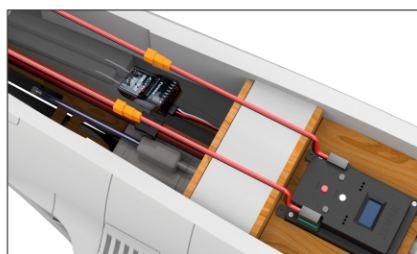

2. Connect the Super integrated control box with 2 sets of 2S lipo batteries;



3. Open the radio transmitter.

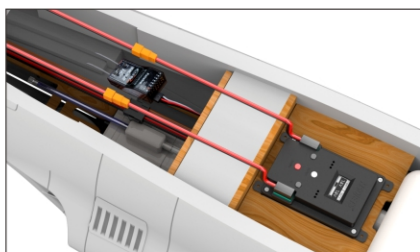

4. Super integrated control box start up. (For details on start up operations, kindly see the MFC-2085 multi-function flight controller system english menu introduction & quick entrance)

5. Check the Super Integrated Control Box S-BUS mode channel settings. The factory default channel is: S-BUS Setting

(Note: You can change the default gear switch position according to your own custom channel.)

- |                        |                                  |
|------------------------|----------------------------------|
| 1.AUX1 CH(default CH1) | 7.AUX7 CH(default CH7)           |
| 2.AUX2 CH(default CH2) | 8.AUX8 CH                        |
| 3.AUX3 CH(default CH4) | 9.A/B LIGHT CH (default CH3)     |
| 4.AUX4 CH(default CH6) | 10.NAV,LIGHT CH (default CH9)    |
| 5.AUX5 CH              | 11.WHEEL BRAKE CH (default CH8)  |
| 6.AUX6 CH(default CH3) | 12.LANDING GEAR CH (default CH5) |

**6. Aileron test:** Check whether the aileron action is correct

### Right model throttle radio transmitter

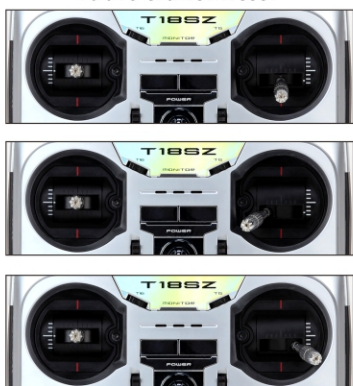

### Aileron standard action

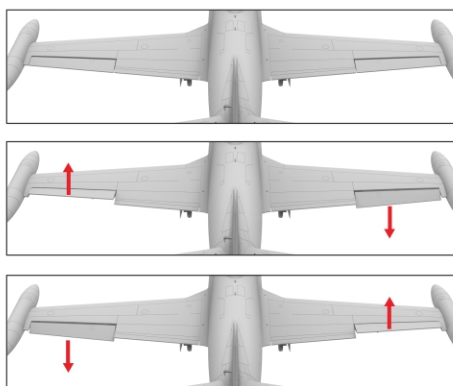

### Possible ailerons reverse action

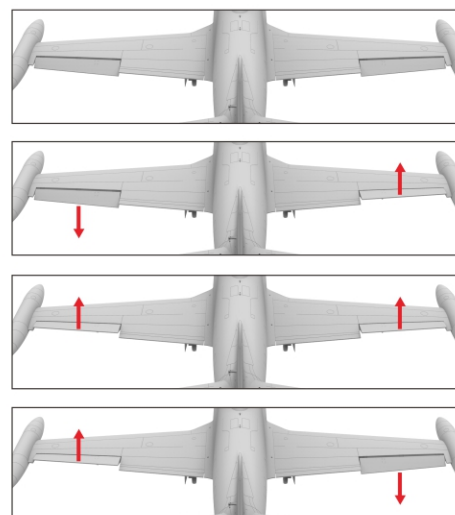

**Note:** If there is no special explanation, this user guide is introduced by default with the right model throttle radio transmitter as an example.

When the aileron action is opposite to the specified action, you can adjust it with the 2 ways as below:

- (1). to find the reverse setting menu of servo in the radio transmitter menu, and switch in the aileron item to the forward direction.
- (2). Adjust directions of the aileron servo through the Super integrated control box (for details, pls see the MFC-2085 multi-function flight controller system english menu introduction & quick entrance);

## First test and adjustment after assembly

**Aileron adjustment:** After the setting, the standard position of the rudder surface will be adjusted. The aileron rudder surface should be in the same plane as the wing. If there is an upward or downward adjustment, it can be adjusted by physical adjustment or system adjustment;

- (1). Physical adjustment: by adjusting the length of the pull rod to change the rudder surface angle to keep it in the same plane as the wing;
- (2). System adjustment A: fine-tuning by the radio transmitter;

- (3). System Adjustment B: Adjust the neutral point of the servo through the Super integrated control box (for details, pls see the MFC-2085 multi-function flight controller system english menu introduction & quick entrance);

The radio transmitter is recommended to use the 100 % amount of servo, adjusting the EXP curve under the same amount of servo, it recommends to adjust to 50 % EXP value in the first time; Can adjust according to the personal operating habits.



**Suggest the amount of servo:**

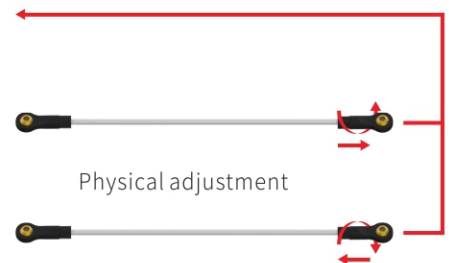
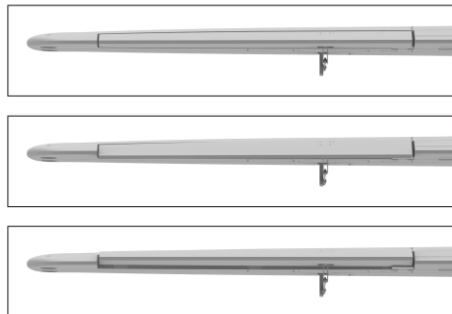
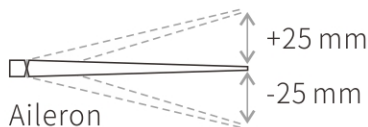

### 7. Elevation test: Check whether the elevate action is correct

**Right model throttle radio transmitter**



**Elevation standard action**

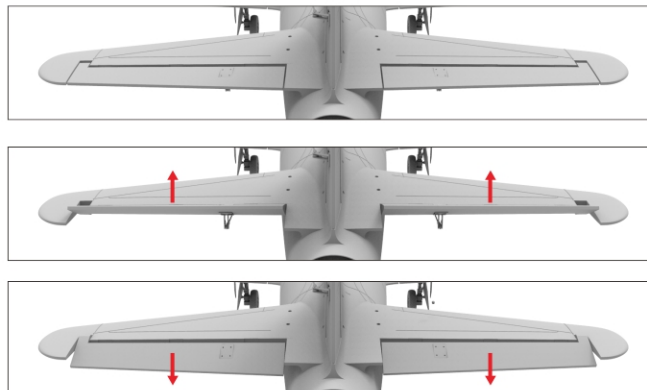

**Note:** If there is no special explanation, this user guide is introduced by default with the right model throttle radio transmitter as an example.

**Possible elevation reverse action**

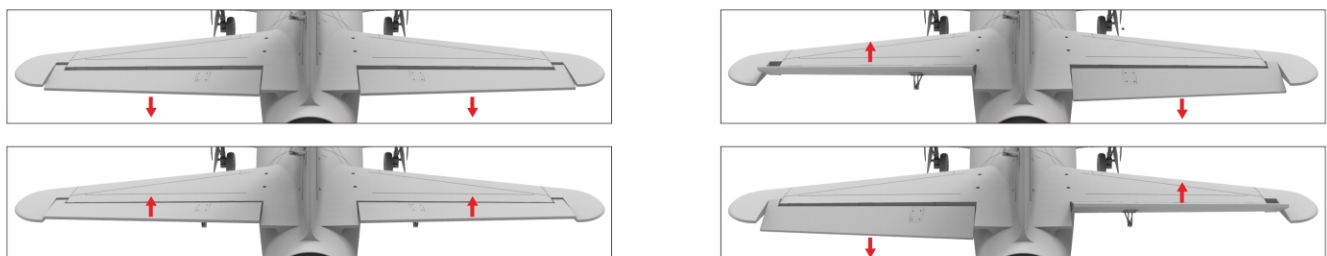

When the elevate action is opposite to the specified action, you can adjust it with the 2 ways as below:

- (1). to find the reverse setting menu of servo in the radio transmitter menu, and switch in the elevate item to the forward direction.
- (2). Adjust directions of the elevate servo through the Super integrated control box (for details, pls see the MFC-2085 multi-function flight controller system english menu introduction & quick entrance);

## First test and adjustment after assembly

**Elevation adjustment:** After the setting, the standard position of the rudder surface will be adjusted. The elevate rudder surface should be in the same plane as the horizontal tail. If there is an upward or downward adjustment, it can be adjusted by physical adjustment or system adjustment;

- (1). Physical adjustment: by adjusting the length of the pull rod to change the rudder surface angle to keep it in the same plane as the wing;
- (2). System adjustment A: fine-tuning by the radio transmitter;

- (3). System Adjustment B: Adjust the neutral point of the servo through the Super integrated control box (for details, pls see the MFC-2085 multi-function flight controller system english menu introduction & quick entrance);

The radio transmitter is recommended to use the 100 % amount of servo, adjusting the EXP curve under the same amount of servo, it recommends to adjust to 50 % EXP value in the first time; Can adjust according to the personal operating habits.

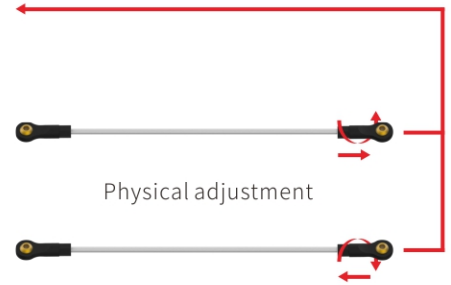
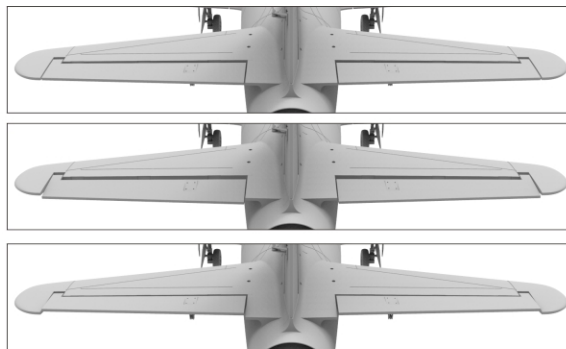

**Suggest the amount of servo:**

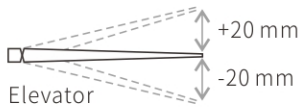

### 8. Direction test: Check whether the direction action is correct

#### Direction standard action

Right model throttle radio transmitter

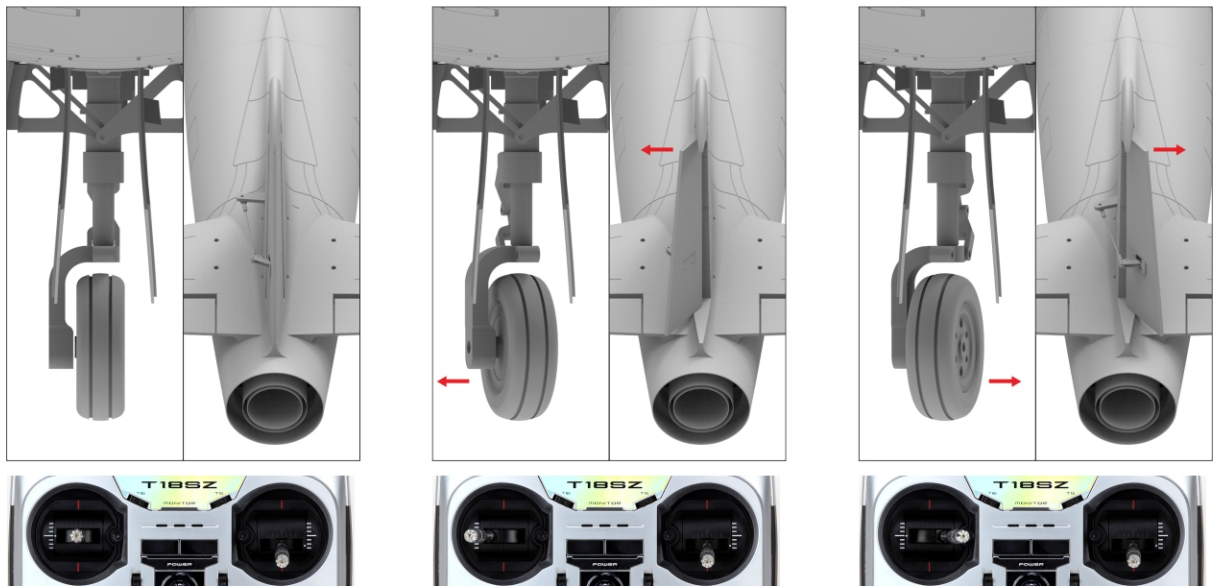

**Note:** If there is no special explanation, this user guide is introduced by default with the right model throttle radio transmitter as an example.

## First test and adjustment after assembly

### Possible direction reverse action

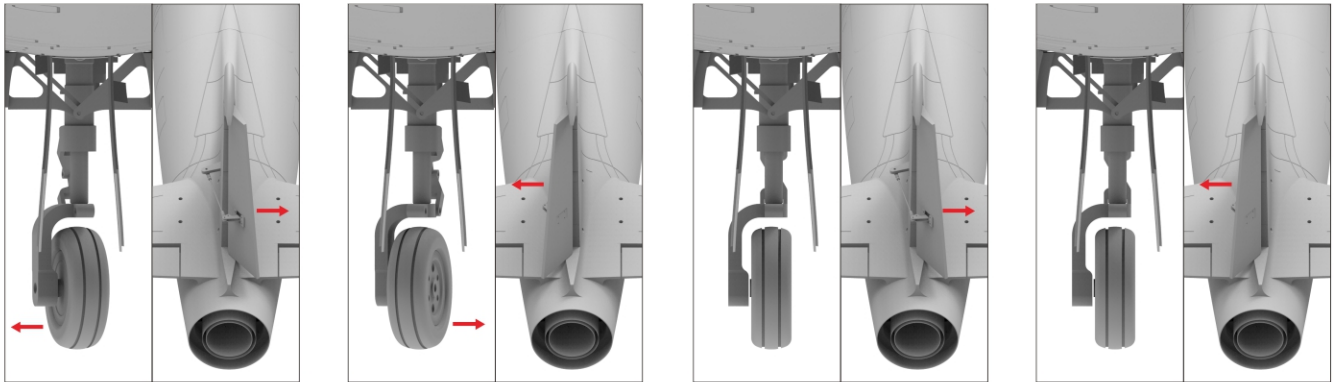

When the direction action is opposite to the specified action, you can adjust it with the 2 ways as below:

- (1). to find the reverse setting menu of direction in the radio transmitter menu, and switch in the direction item to the forward direction.
- (2). Adjust directions of the direction servo through the Super integrated control box (for details, pls see the MFC-2085 multi-function flight controller system english menu introduction & quick entrance);

**Direction adjustment:** After the setting, the standard position of the rudder surface will be adjusted. The direction rudder surface should be in the same plane as the vertical tail. If there is a left or right deviation need to be adjusted to vertical center, it can be adjusted by physical adjustment or system adjustment;

- (1). Physical adjustment: by adjusting the length of the pull rod to change the rudder surface angle to keep it in the same plane as the wing;
  - (2). System adjustment A: fine-tuning by the radio transmitter;
  - (3). System Adjustment B: Adjust the neutral point of the servo through the Super integrated control box (for details, pls see the MFC-2085 multi-function flight controller system english menu introduction & quick entrance);
- The radio transmitter is recommended to use the 100 % amount of servo, can adjust according to the personal operating habits.
- The front landing gear steering is adjusted with the direction of the rudder surface. If you need to adjust one of them alone, it can be completed by adjusting the neutral point of the servo through the Super integrated control box. (for details, pls see the MFC-2085 multi-function flight controller system english menu introduction & quick entrance);

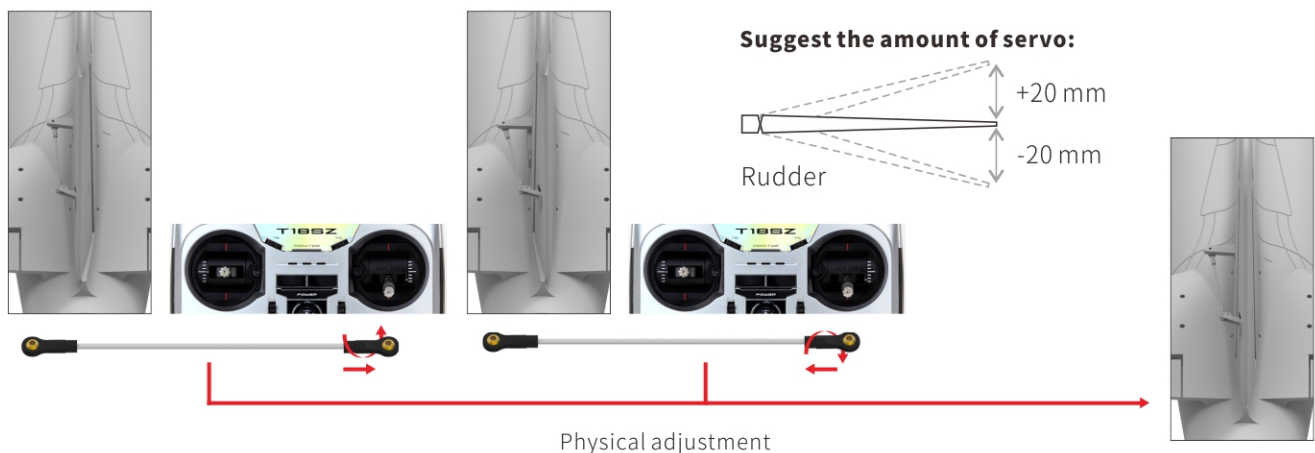

## First test and adjustment after assembly

### 9. Flap test: Check whether the flap action is correct

#### Flap standard action

Right model throttle radio transmitter

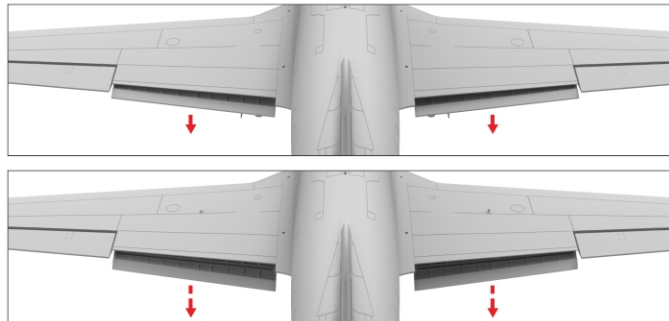

**Note:** If there is no special explanation, this user guide is introduced by default with the right model throttle radio transmitter as an example.

#### Possible flap reverse action

**The flap compensation:**  
**Factory default compensation 3%, customers according to their own needs can be increased or reduced;**

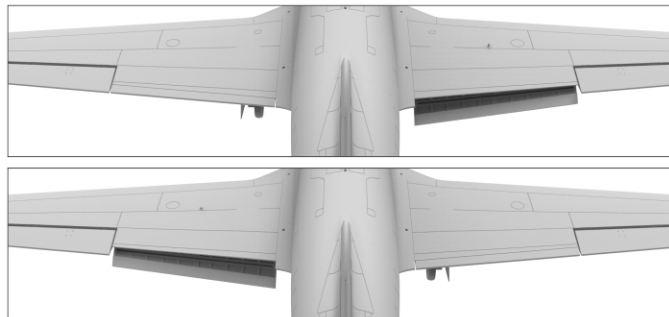

When the two flaps don't move in the same direction: adjust directions of the flap servo through the Super integrated control box (for details, pls see the MFC-2085 multi-function flight controller system english menu introduction & quick entrance);

**Flaps adjustment:** After the setting, start checking the flaps rudder surface, if the angles of the flaps rudder surface are consistent in first grade, and whether the angles of the flaps rudder surface are consistent in second grade. If the angles of the rudder surfaces on both sides are inconsistent, it can be adjusted by physical adjustment or system adjustment;

(1). Physical adjustment: by adjusting the length of the pull rod to change the angle of the rudder surface to keep it at the same angle as the two rudder surfaces;

(2). Through the Super integrated control box to adjust the wing steering gear stroke to solve (for details, pls see the MFC-2085 multi-function flight controller system english menu introduction & quick entrance); The radio transmitter is recommended to use the 100% amount of servo, can adjust according to the personal operating habits.

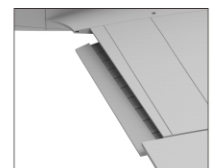
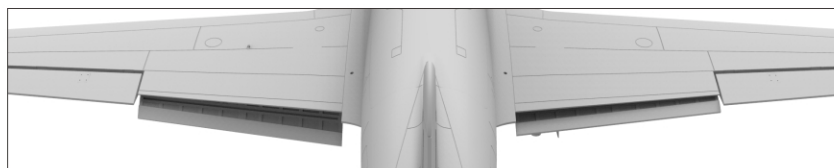
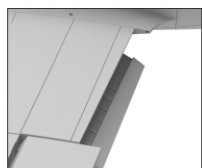

**Suggest the amount of servo:**

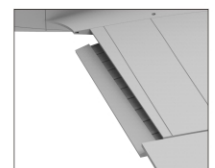
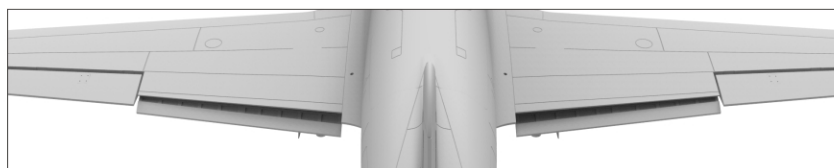
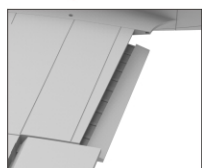
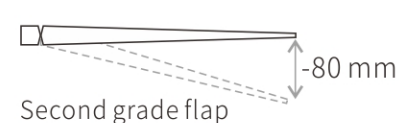
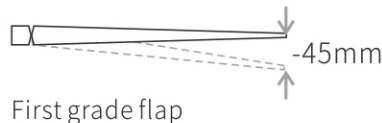



## First test and adjustment after assembly

### 10. Landing gear testing and adjustment:

Note: The Super integrated control box insert a avoid error retraction program. After each power on, the landing gear retraction function is used for the first time. It is necessary to move the landing gear switch of the radio transmitter back and forth to remove the avoid error retraction program;

Check whether the landing gear is working properly. If the landing gear retract, the landing gear lamp is open, indicating that the landing gear is the opposite, the reason is the positive and negative pole lines of the electric retraction are reverse inserted. It is necessary to replace the positive and negative poles of the electric retraction from the Super integrated control box (for details, pls see the MFC-2085 multi-function flight controller system english menu introduction & quick entrance);

If the three are not in the same step and one up and two down or two up and one down, to change the insertion of positive and negative poles to solve.(for details, pls see the MFC-2085 multi-function flight controller system english menu introduction & quick entrance);

MFC-2085 Super Integrated Control Box has a one-click retractable landing gear function (for details, pls see the MFC-2085 multi-function flight controller system english menu introduction & quick entrance);

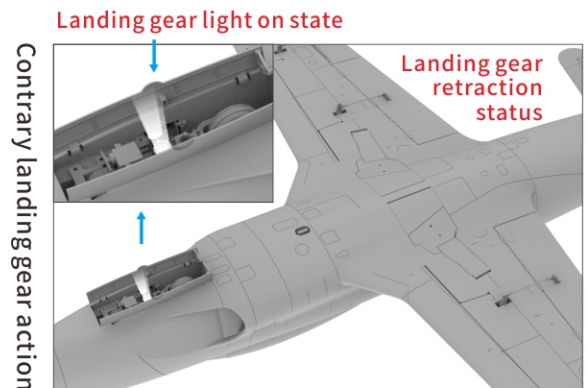
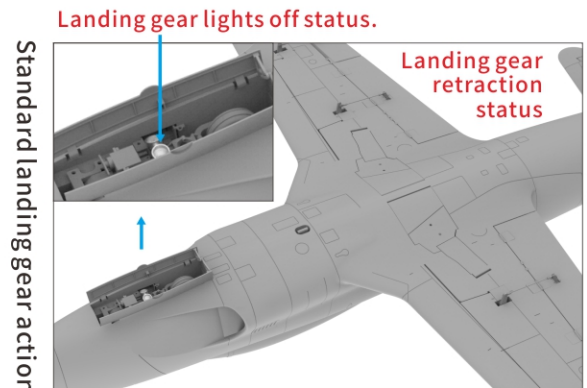

Standard landing gear action

Possible landing gear reverse action

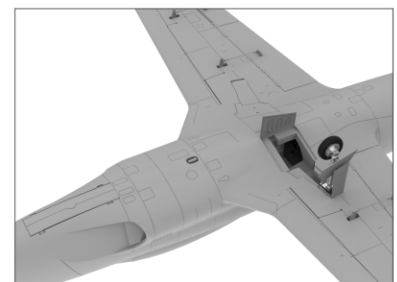
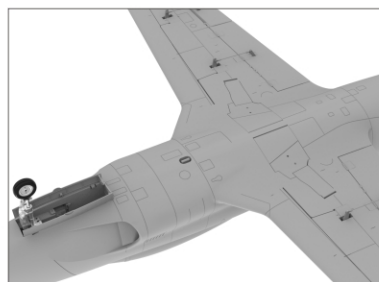
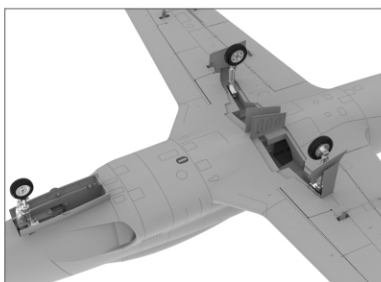
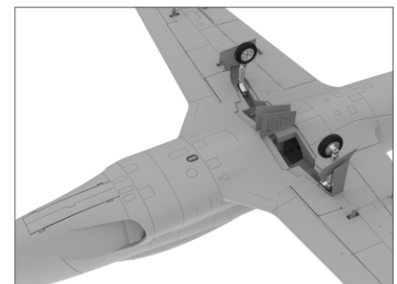
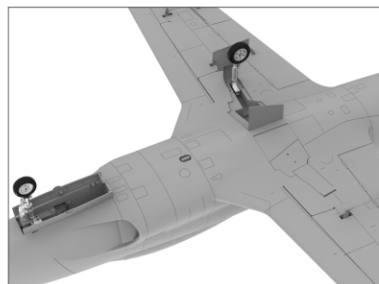
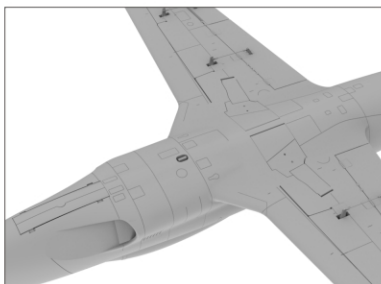

## First test and adjustment after assembly

**11. Ground test and adjustment:** After the above process is gradually completed, power the plane and do straight slide test to check whether the stroke volume of the front steering servo is full. If the steering is yaw or the steering angle is too large, it can be adjusted by physical adjustment or system adjustment:

(1).Steering yaw adjustment:

- ①. physical adjustment: Complete it by adjusting the length of the front wheel steering rod;
- ②. System Adjustment A: Adjust the servo stroke by the Super Integrated Control Box(for details, pls see the MFC-2085 multi-function flight controller system english menu introduction & quick entrance);
- ③.System adjustment B: Adjust by radio transmitter stroke.

(2).Excessive adjustment of steering angles:

- ①.Physical adjustment: adjust the install holes of the pull rod in the rocker arm of the steering servo of the front wheel;
- ②.System Adjustment A: Adjust the servo stroke through the Super Integrated Control Box(for details, pls see the MFC-2085 multi-function flight controller system english menu introduction & quick entrance);
- ③.System adjustment B: Adjust by radio transmitter stroke.

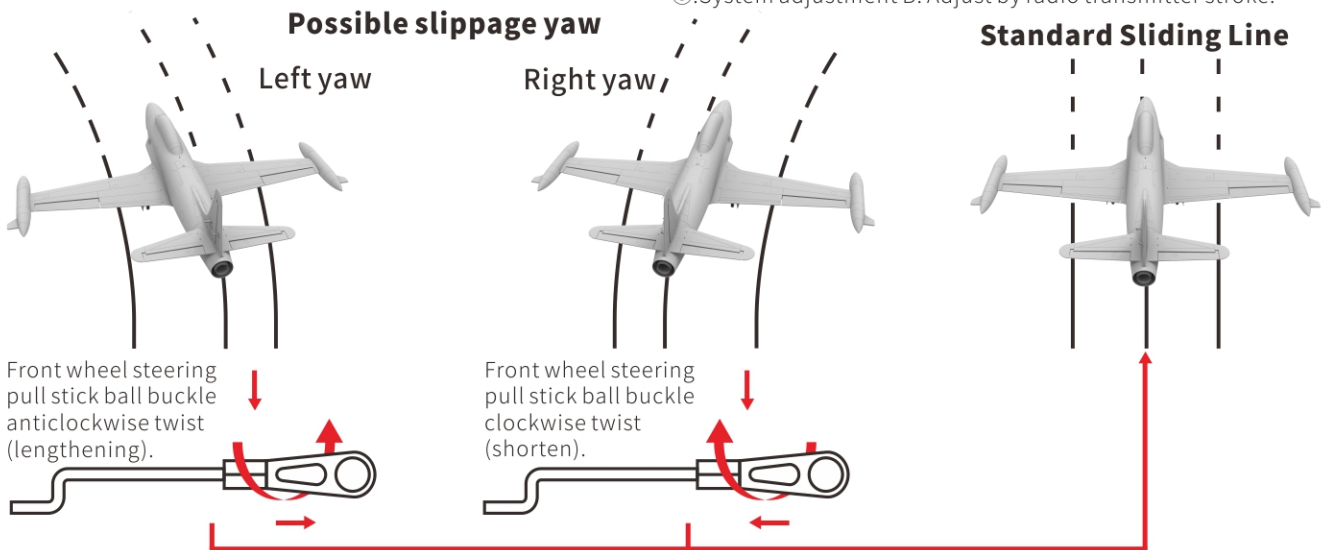

### The skid yaw angle over or smaller may happened during the operation

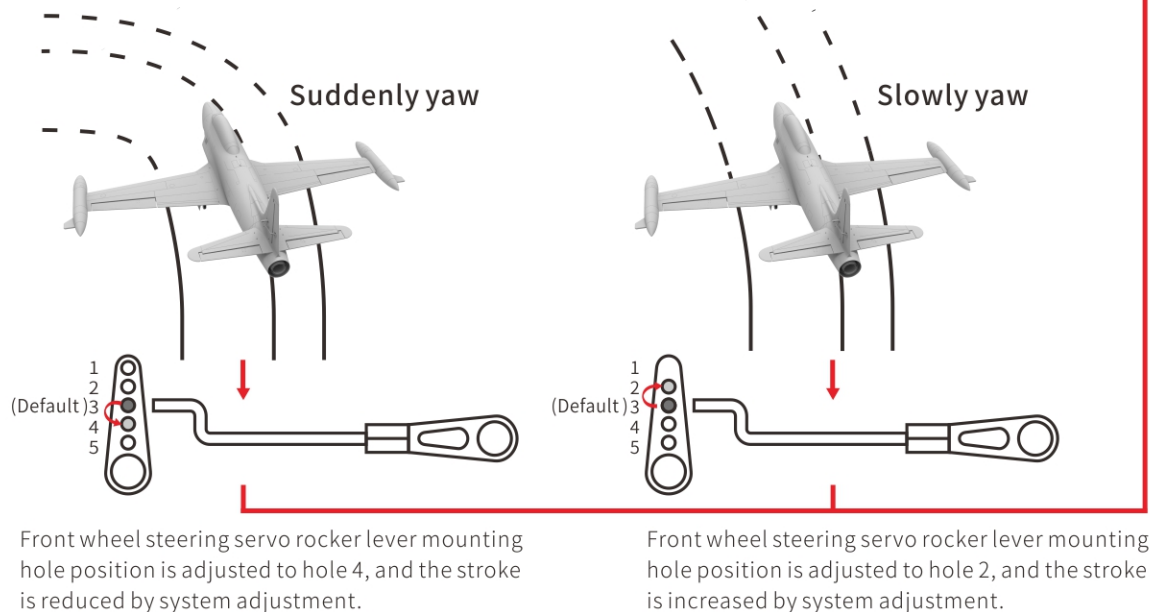

## First test and adjustment after assembly

### 12. Pre-takeoff center of gravity

**test:** Before the aircraft takes off, it is necessary to confirm whether the center of gravity of the aircraft is correct. The center of gravity of the Super snake is located behind the front edge of the main wing: 180mm.

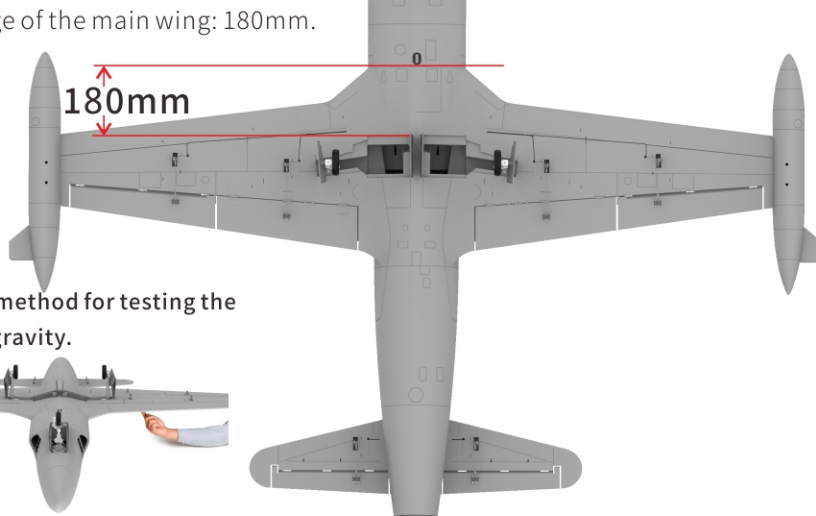

A general method for testing the center of gravity.



**Center of gravity adjustment:** If the center of gravity position is not correct, it must be adjusted. There are generally two situations:

A, the nose is overweight (the nose of the aircraft is drooping during the center of gravity testing on the ground), can move the battery back to the tail or replaced with a smaller capacity battery that within the scope of the aircraft's electricity demand;

B, the nose is too light (the nose of the aircraft is upwards during the center of gravity testing on the ground), move the battery forward to the nose or replaces the larger capacity battery that within the scope of the aircraft's electricity demand;

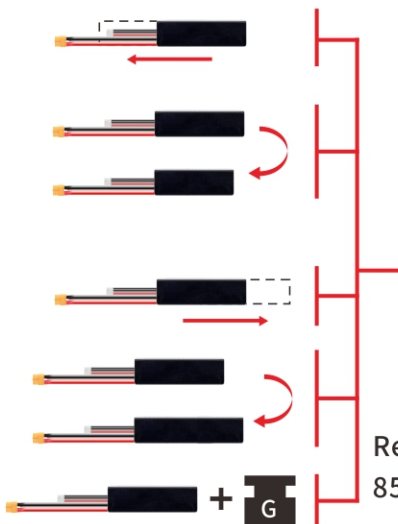
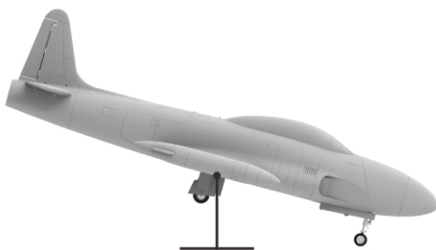

### Battery assembly diagram

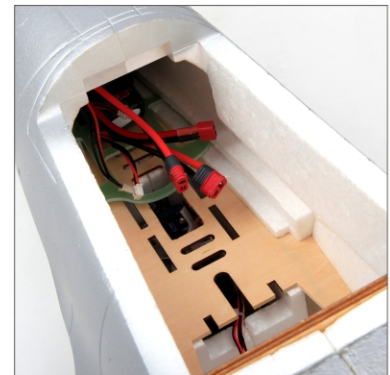
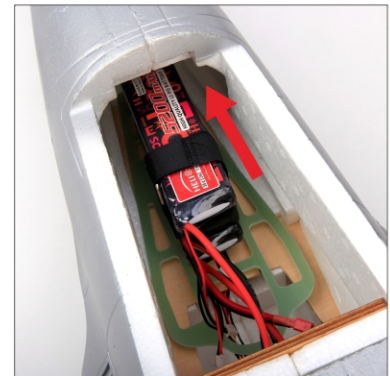

**Recommended battery weight:**  
850 g Fully matched center of gravity.

## Landing gear decomposition graph



## Landing gear decomposition graph

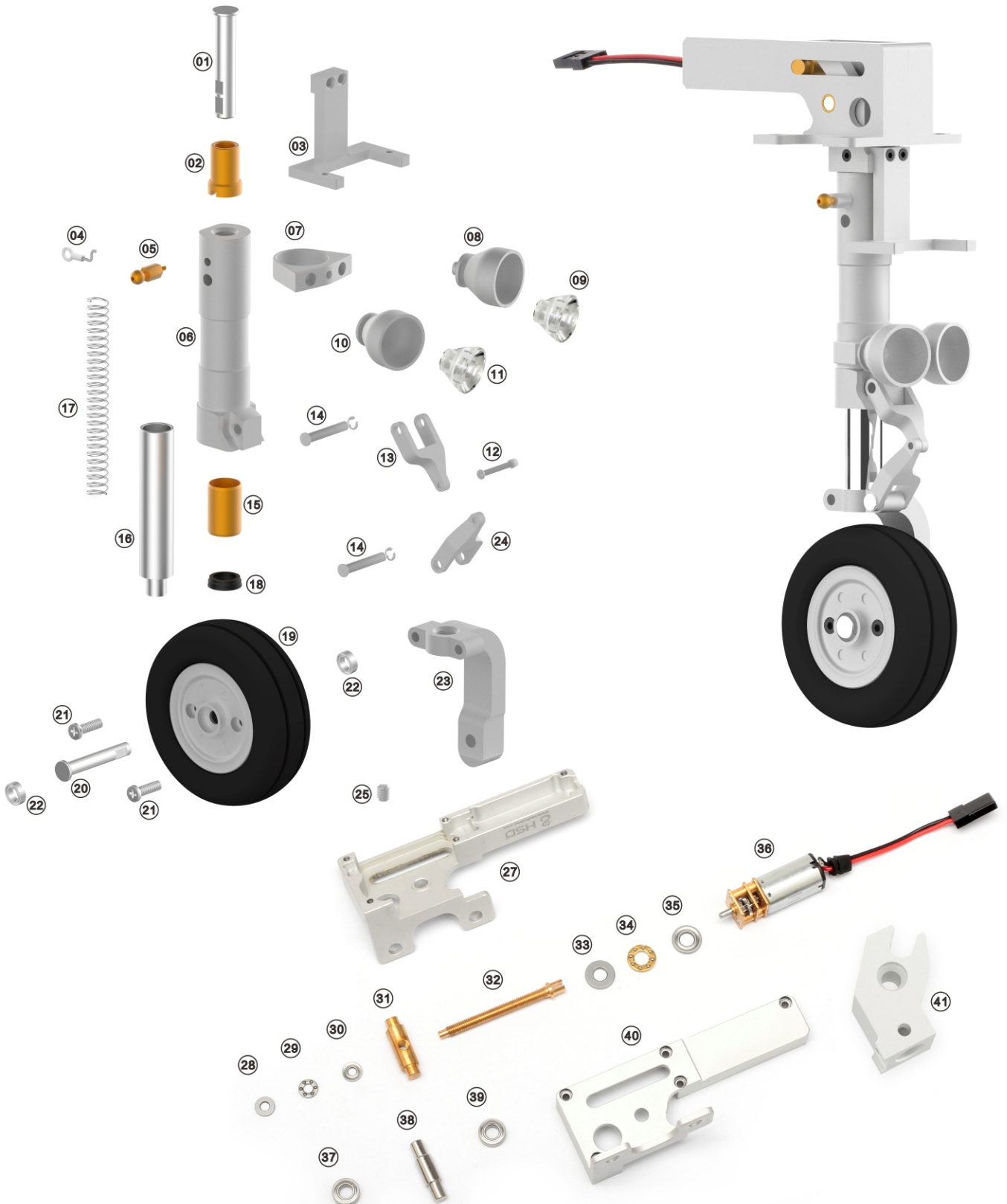

## Specification and configuration

### Specifications:

Wingspan	2018 mm / 79.4 in
Length	1800 mm / 70.9 in
Take off weight	10.7 kg / 23.5 lb(with 1800cc Aviation kerosene)
Crusing speed	150~200 km/h
Flying time	3~5 minutes
Main wing area	56.5 dm <sup>2</sup>
Loading of airfoil surface	184.1 g/dm <sup>2</sup>
Main material	20 times the import of aeromodelling EPO
Body Surface Treatment	Matte environmental water-borne paint + decal
Suitable experience level	<input type="checkbox"/> Zero basis <input type="checkbox"/> Beginner <input checked="" type="checkbox"/> Intermediate <input type="checkbox"/> Advanced
PNP assembly difficulty	<input type="checkbox"/> ☆(10mins) <input type="checkbox"/> ★(20mins) <input checked="" type="checkbox"/> ★★☆(30mins) <input type="checkbox"/> ★★★(60mins) <input type="checkbox"/> ★★★★(120mins)
Operate suitable for age	Above 18 years of age
Working temperature	0°C ~ 40°C

### Configuration:

Remote control channel	7CH (Selective configuration)
Control system	MFC-2085
Configuration of engine thrust	8kg
Power battery	According to engine matching (Selective configuration)
Receiver battery	2S / 7.4V / 5200 mAh Li-Po × 2 PCS (Selective configuration)
Servo	12g × 4 PCS / 25g × 7 PCS (Metal gear digital)
Landing gear	All-metal simulation electronic retractable landing gear
Brake function	Yes
LED Lighting System	Yes
Aileron	Yes
Flaps	Yes
Horizontal tail	Yes
Vertical tail	Yes
Reinforced gyro	Selective configuration
Packaging	Inner box + Outer Box (with marks)
Center of gravity	180 mm leading edge of main wing





扫码关注，谢谢支持！

🌐 [www.hsdrc.com](http://www.hsdrc.com)

✉ [hsd@hsdjetshuangasai.com](mailto:hsd@hsdjetshuangasai.com)

📍 Company address : HSD Industry Park, Aigang Industry District, Huaide, Humen Town, Dongguan City, Guangdong Province, China (Post: 523926)

📍 Production address : Building F6, Standardized Factory Buildings, Xixiu Industrial Park, Xixiu District, Anshun City, Guizhou Province, China (Post: 561099)